

CORTINA DE CRISTAL  
**CORREDERA MICA**  
MICA MULTITRACK SYSTEM

 **Todocrystal**<sup>®</sup>

## Corredera Mica Mica Multitrack System

El sistema de Corredera de Cristal de Mica se caracteriza por sus paneles de cristal que se desplazan horizontalmente, sin necesidad de perfiles verticales, y se apilan en un extremo del sistema. Cada panel está equipado con un perfil minimalista en la parte inferior, donde se encuentran los elementos que permiten un movimiento suave y fluido. Los rodamientos tipo tándem facilitan la nivelación del panel en 6 mm por extremo y garantizan un desplazamiento suave. Además, el panel cuenta con un sistema de arrastre con elementos metálicos, asegurando así un sistema robusto y eficiente.

El peso del sistema se apoya en el carril inferior, que dispone de un sistema de desagüe interno para instalaciones sobre el suelo o un sistema de carriles de altura reducida para instalaciones embutidas, evitando protuberancias en el suelo. El diseño actualizado de los carriles ha permitido reducir la distancia entre los raíles de deslizamiento, logrando así un sistema más compacto.

En cuanto a los sistemas de cierre, se ofrece tanto El Cierre Ergo, así como una cerradura Corredera con Llave, y opcionalmente se pueden agregar perfiles verticales en los extremos para mejorar la estanqueidad del sistema.

The multitrack Mica System is characterized by its glass panels that slide horizontally, without the need for vertical profiles, and stack at one/two end sides of the system. Each panel is equipped with a minimalist profile at the bottom, where the elements allowing smooth and fluid movement are located.

Tandem-type bearings facilitate panel leveling by 6 mm per end and ensure smooth displacement. Additionally, the panel features a drag system with metallic elements, thus ensuring a robust and efficient system.

The weight of the system is supported by the bottom rails, which have an internal drainage system for floor installations or a low-height rail system for recessed installations, avoiding protrusions on the floor. The updated design of the rails has reduced the distance between the sliding rails, achieving a more compact system.

Regarding the closing systems, both the Ergo Closure and a Sliding Lock with Key are offered, and optionally, vertical profiles can be added at the ends to improve the systems sealing.



## Características Characteristics

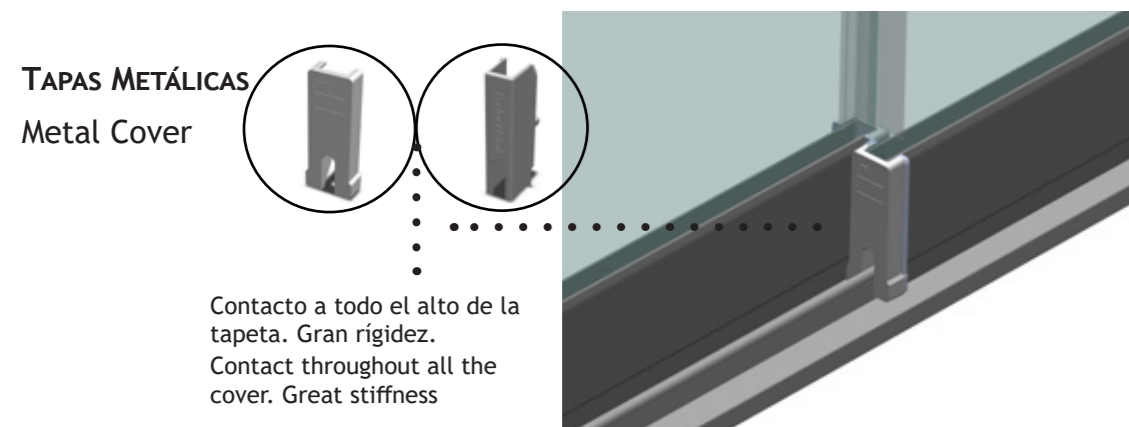

- SOLAPE ENTRE PANELES 18 MM
- 18 mm overlap between panels

SISTEMA DE DESAGÜE INTERNO  
Internal drainage system

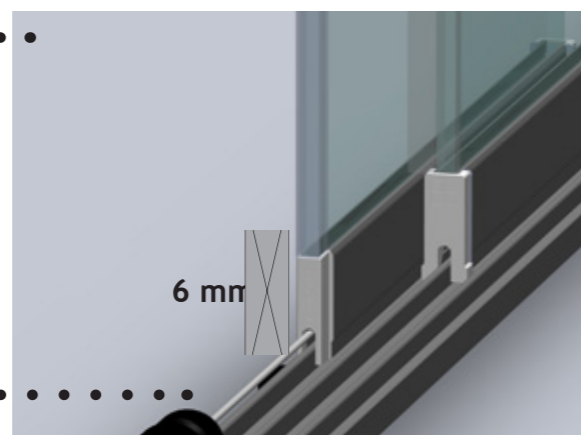
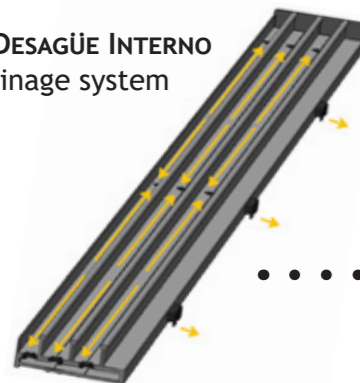

REGULACIÓN CARRO DE RODADURA POR PANEL DE 6 MM.  
6 mm Roller regulation per panel

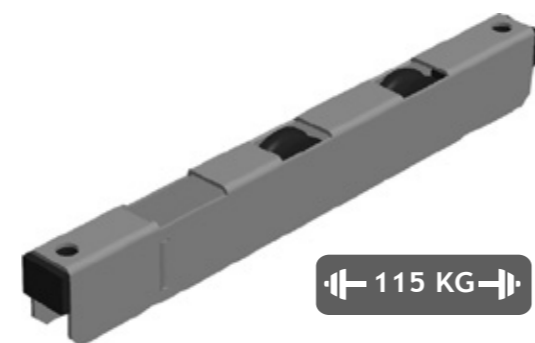

CARRO DE RODADURA (DE ACERO)  
Roller (Steel)

## Características Characteristics

### Cristal

-Templado 10 mm.

### Características

- Sistema de desagüe interno, mejorando el acabado estético del sistema.
- Regulación por panel de 6 mm.
- Los Carros de Rodadura de doble tandem puede soportar cargas de hasta 115 kg.
- Mínimo solape entre paneles de 18 mm.

### Configuraciones

- El sistema de Corredera MICA cuenta con carriles de 3,4 y 5 raíles, permitiendo realizar combinaciones de hasta 10 paneles con doble apertura

### Colores

- Estándar: Blanco o Crudo.
- Lacados en todos los colores RAL.
- Anodizados.
- Lacados Imitación Madera.
- Las tapas metálicas son en acabado plata mate

### Tamaños Máximos

- 3.000 mm altura máxima.
- Panel mínimo 400 mm,
- Panel máximo 1.200 mm,
- Panel estándar 800 mm.

### Glass:

- Tempered 10 mm.

### Features:

- Internal drainage system, improving the system's aesthetic finish.
- Panel adjustment of 6 mm.
- Rolling Carriages can support loads of up to 115 kg.
- Minimum overlap between panels of 18 mm.

### Configurations:

- The multitrack MICA System has 3, 4 and 5 rail tracks, allowing combinations of up to 10 panels with double opening.

### Colors:

- Standard: White or Raw.
- Lacquered in all RAL colors.
- Anodized.
- Wood Imitation Lacquered.
- Metal covers finish are in silver matte

### Maximum Sizes:

- Maximum height of 3,000 mm.
- Minimum panel 400 mm,
- Maximum panel 1.200 mm,
- Standard panel 800 mm.



## Complementos de Cierre Closing Accesories

### 1 PERFILES Profiles

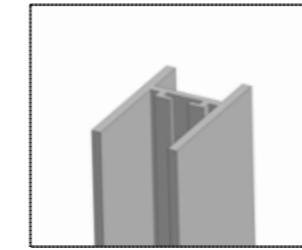
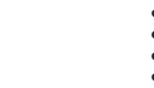

**PERFIL VERTICAL MICA**  
Mica Vertical Profile

### 2 TIRADORES DE PANELES Panels handle



**POMO**  
Knob

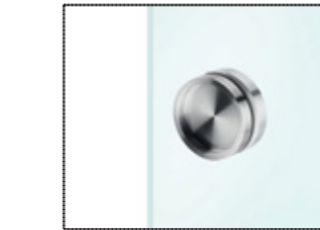

**UÑERO**  
Pocket door pull

### 3 CERRADURAS Locks



**CIERRE DE CORREDERA MAXI  
Y CERROJO DE PLACA**  
Sliding Door Lock Maxi  
With Plate

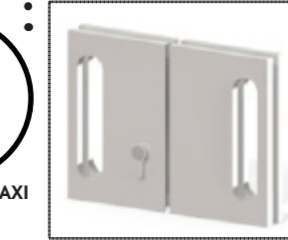

**CIERRE DE CORREDERA MAXI  
Y CERROJO**  
Sliding Door Lock  
With Strike Plate

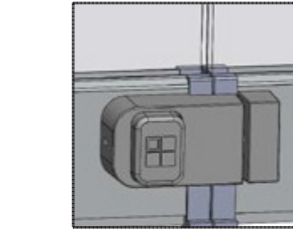

**CIERRE ERGO**  
Ergo Lock

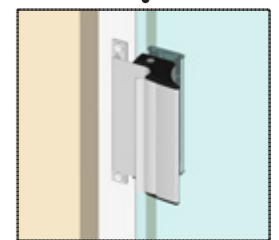

**CIERRE KOMO**  
Sliding Door Komo

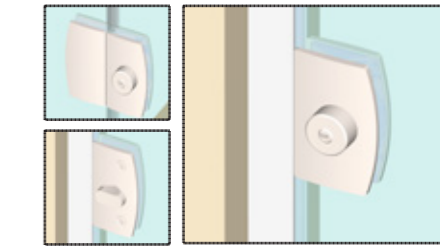

**CIERRE DE CORREDERA MINI  
Y CERROJO**  
Sliding Door Lock  
With Strike Plate

# Carriles Tracks

# Medidas de Carriles Tracks Dimensions

CARRIL SUPERIOR Top track

3R

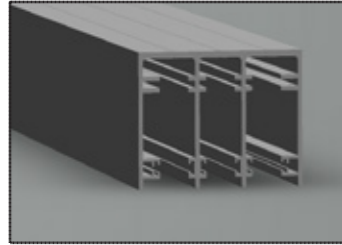

4R

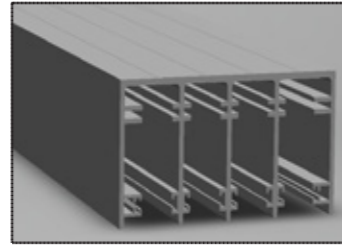

5R

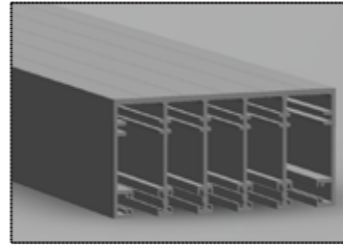

CARRIL SUPERIOR Top track

3R

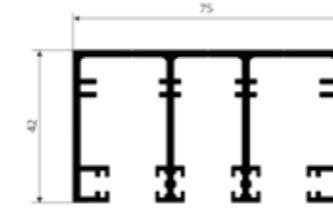

4R

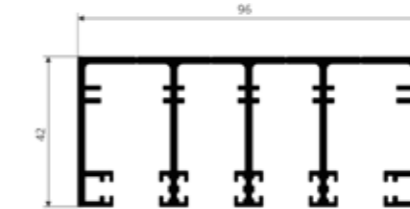

5R

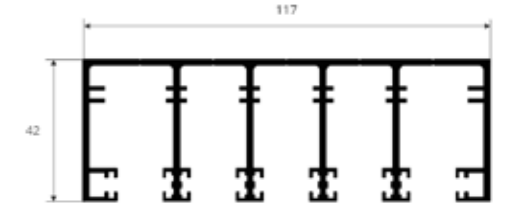

CARRIL INFERIOR SOBRE SUELO Above ground Bottom track

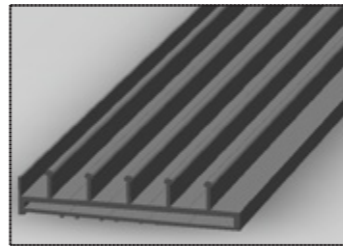
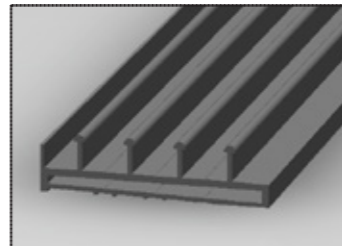
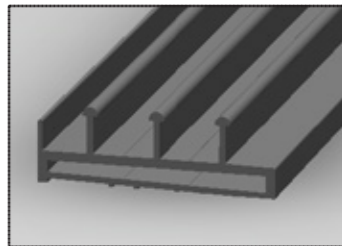

CARRIL INFERIOR SOBRE SUELO Above ground Bottom track

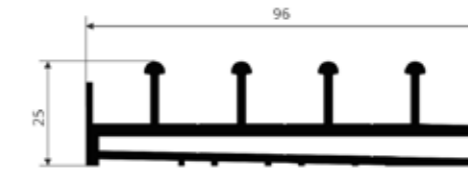
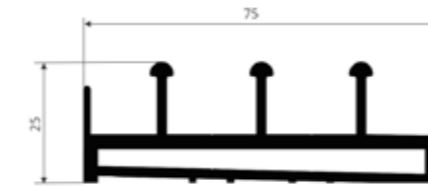

CARRIL INFERIOR EMBUTIDO Embedded bottom track

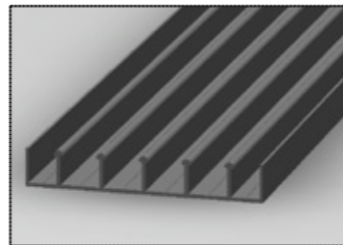
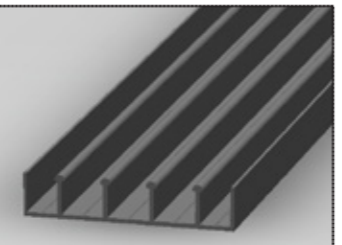
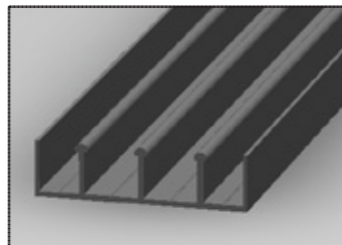

CARRIL INFERIOR EMBUTIDO Embedded bottom track

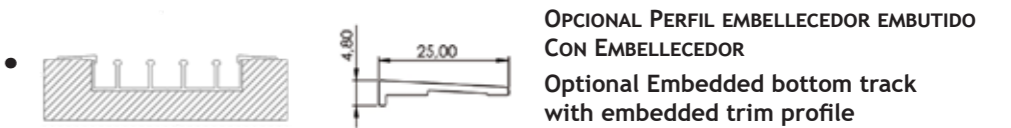
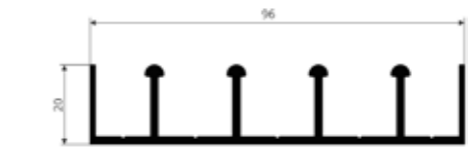



## Terminaciones a Pared Against Wall

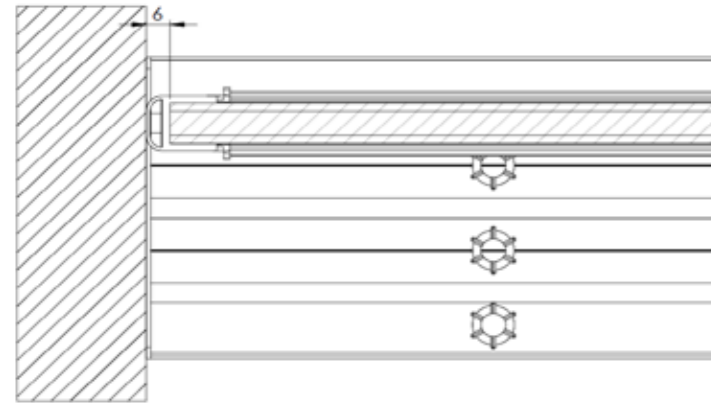

SIN PERFIL VERTICAL MICA  
Without Mica Vertical profile

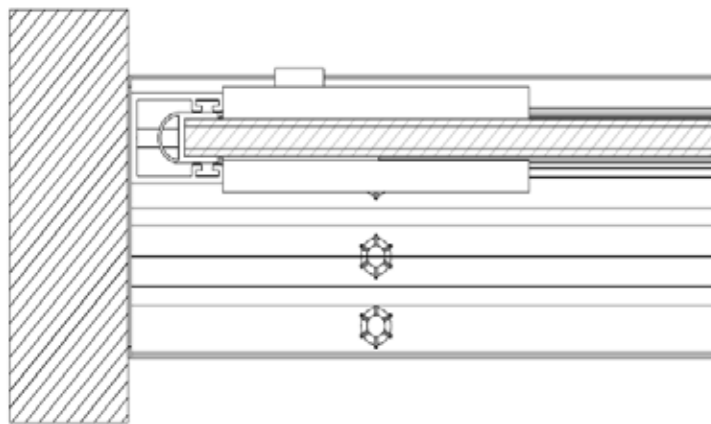

OPCIÓN CERRADURA  
Option with Lock

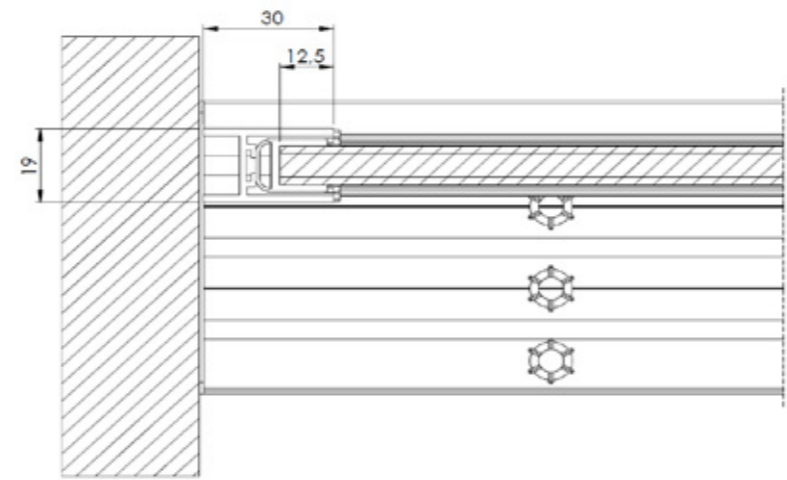

CON PERFIL VERTICAL MICA  
With Mica Vertical profile



## Explosionado del Sistema y del Panel System and panel Exploded view

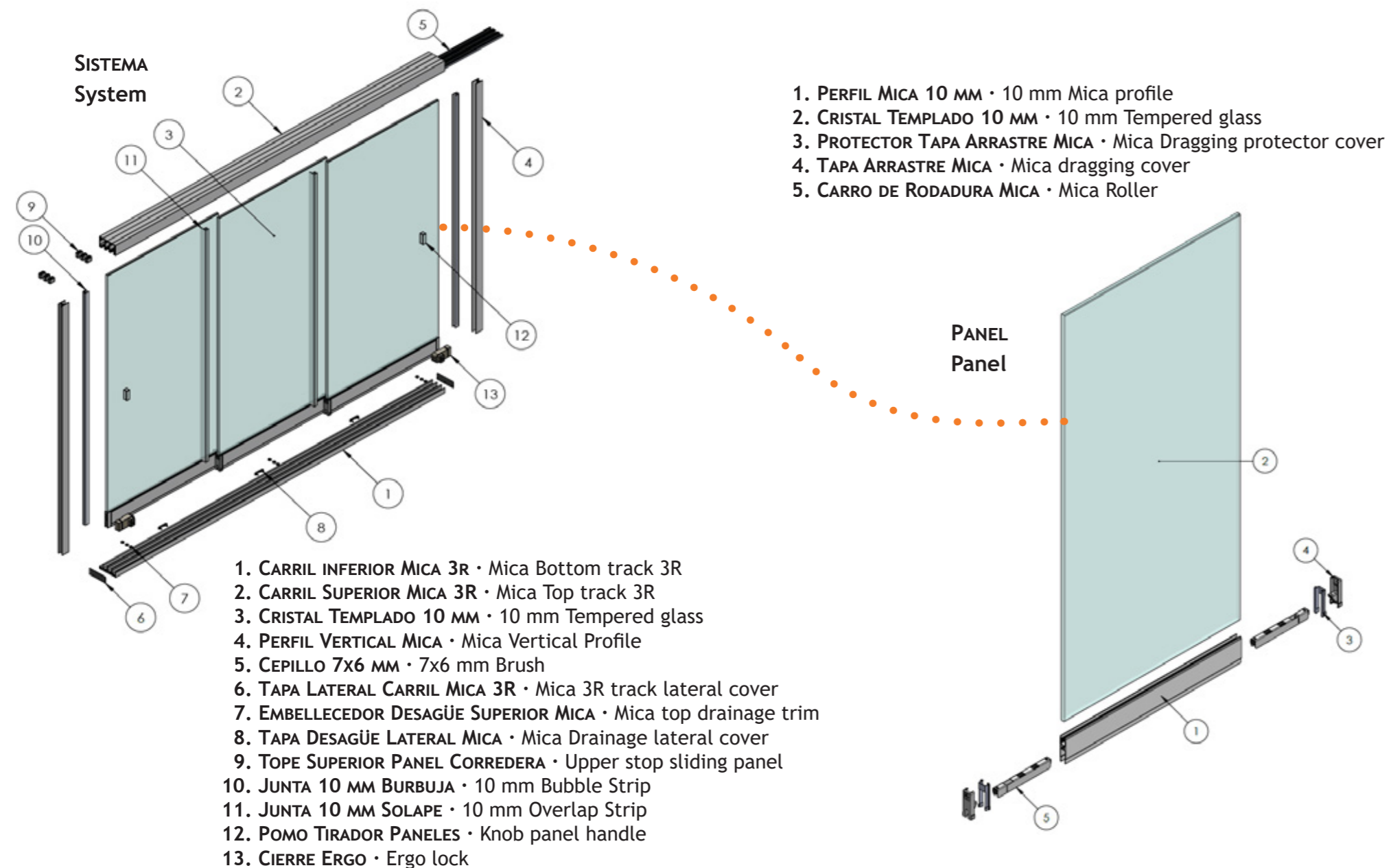

## Sellos de Calidad Quality seals



### Marcado CE

Nuestra Corredera tiene el marcado CE certificado por Applus+  
**Comprometidos con la calidad y el medio ambiente**  
 Certificaciones en las normas ISO 9001: 2015 e ISO 14001:2015



### CE Marking

Our Multitrack System has the CE marking certified by Applus+  
**Committed to quality and the environment**  
 Certifications in ISO 9001:2015 and ISO 14001:2015



**PYME INNOVADORA**  
 Válido hasta el 22 de agosto de 2025



 	
<p><i>Allglass Confort Systems, S. L</i>                  Paseo de la Hispanidad. nave 49 - 51                  Pol. Ind. "Alhaurín de la Torre"                  29130 Málaga - España</p> <p>2024</p>	
<p>UNE - EN 14351 - 1 : 2006 + A2 : 2017</p>	
<p><b>Material ensayado:</b>                  Puerta de Cristal de tres hojas correderas de dimensiones exteriores 2400x2500                  Puerta de Cristal de tres hojas correderas de dimensiones exteriores 3200x2500</p>	
Carga de Viento:	Clase 1 (500 Pa)
Prestaciones Acústicas:	35 db
Transmitancia Térmica:	5,64 w/ m <sup>2</sup> K
Permeabilidad del aire:	Clase 1
Estanqueidad del Agua:	Clase 1A
Sustancias Peligrosas:	No





info@todocrystal.eu · + 34 952 17 20 88

 **Todocrystal**<sup>®</sup>